

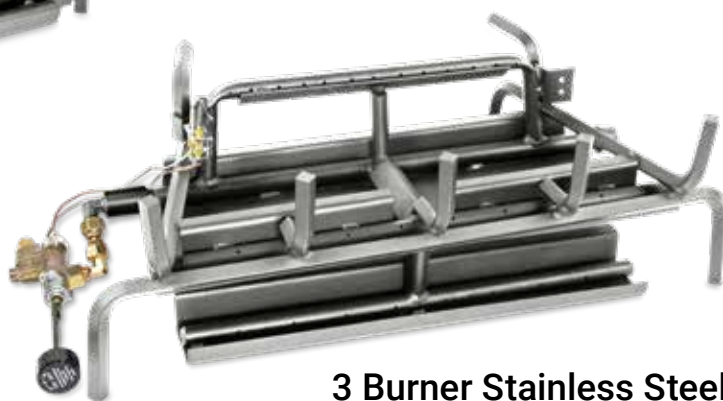

2 BURNER / 3 BURNER STAINLESS STEEL INSTALLATION AND OPERATION MANUAL



2 Burner Stainless Steel
w/ Millivolt



3 Burner Stainless Steel
w/ Safety Pilot

⚠️ WARNING

WARNING: If the information in this manual is not followed exactly, a fire or explosion may result causing property damage, personal injury, or loss of life.

FOR YOUR SAFETY: Do not store or use gasoline or other flammable vapors and liquids in the vicinity of this or any other appliance.

WHAT TO DO IF YOU SMELL GAS

- Do not try to light any appliance.
- Do not touch any electrical switch; do not use any phone in your building.
- Immediately call your gas supplier from a neighbor's phone. Follow the gas supplier's instructions.
- If you cannot reach your gas supplier, call the fire department.
- Installation and service must be performed by a qualified installer, service agency, or the gas supplier.

INSTALLER: Leave this manual with appliance. **CONSUMER:** Retain this manual for future reference.



WEBSITE



FOR INDOOR OR OUTDOOR PATIO USE

Certified to the Canadian and American National Standards: CSA 2.26 and ANSI Z21.60 for decorative gas appliances for installation in solid-fuel burning fireplaces.

Grand Canyon Gas Logs

3515 East Atlanta Avenue, Phoenix, Arizona 85040 | 602-344-4217 | grandcanyongaslogs.com

07-00135 | 062024_V1

SAFETY INFORMATION

WARNING

- Do not operate appliance before reading and understanding operating instructions. Failure to operate appliance according to operating instructions could cause fire or injury.
- **This appliance is hot when operated and can cause severe burns if contacted.**
- **Any changes or alterations to this appliance or its controls can be dangerous and is prohibited.**
- Risk of fire or asphyxiation, do not operate appliance with safety screen removed and never obstruct the front opening of the appliance.
- Risk of burns. The appliance should be turned off and cooled before servicing.
- Do not install damaged, incomplete or substitute components.
- Risk of cuts and abrasions. Wear protective gloves, protective footwear, and safety glasses during installation. Sheet metal edges may be sharp.
- Do not burn wood or other materials in this appliance.
- Provide adequate ventilation and combustion air. Provide adequate accessibility clearance for servicing and operating the appliance.
- **Children and adults should be alerted to hazards of high surface temperature and should stay away to avoid burns or clothing ignition.**
- **Young children should be carefully supervised when they are in the same room as the appliance. Toddlers, young children and others may be susceptible to accidental contact burns. A physical barrier is recommended if there are at-risk individuals in the house. To restrict access to an appliance or stove, install an adjustable safety gate to keep toddlers, young children and other at risk individuals out of the room and away from hot surfaces.**
- **Clothing or other flammable material should not be placed on or near the appliance.**
- **Due to high temperatures, the appliance should be located out of traffic and away from furniture and draperies.**
- Furniture or other objects must be kept a minimum of 36 inches (.9144m) away from the front of the appliance.
- Ensure you have incorporated adequate safety measure to protect infants/toddlers from touching hot surfaces.
- Even after the appliance is off, it will remain hot for an extended period of time.
- Check with your local hearth specialty dealer for safety screens and hearth guards to protect children from hot surfaces. These screens and guards must be fastened to the floor.
- **Any safety screen, guard or barrier removed for servicing the appliance, must be replaced prior to operating the appliance.**
- A fireplace screen must be in place when the appliance is operating unless other provisions for combustion air are provided, the screen shall have openings for the introduction of combusted air.
- Thoroughly clean the chimney, flue and existing appliance before installing the new appliance into it. Do not burn solid fuels in any appliance that is equipped with this gas log set.
- The installation, including provisions for combustion, and ventilation air required minimum permanent vent opening must conform with the NATIONALS FUEL GAS CODE (ANSI Z223.1/NFPA 54) and applicable local building codes.
- Do not operate appliance in the presence of gasoline or other flammable liquids and vapors. Keep area clear of other combustible materials. The appliance and its shut off must be disconnected from the gas supply piping system before any pressure testing of the system is done.
- It is imperative that the control compartments, burners and circulating blower and its passageway in the appliance and venting system are kept clean. The appliance and its venting system should be inspected before use and at least annually by a qualified service person. More frequent cleaning may be required due to excessive lint from carpeting, bedding material, etc. The appliance area must be kept clear and free from combustible materials, gasoline, and other flammable vapors and liquids.
- If the appliance shuts off, do not relight until you provide fresh air. If appliance keeps shutting off, have it serviced. Keep burner and control compartment clean.
- Under no circumstances should this appliance be modified.
- Do not allow wind or fans to blow directly into the appliance. Avoid any drafts that alter burner flame patterns.
- Do not use a blower insert, heat exchanger insert or other accessory not approved for use with this appliance.
- This appliance must not be connected to a chimney flue pipe serving a separate solid fuel burning appliance.



⚠ WARNING

- Do not use this appliance if any part has been underwater. Immediately call a qualified service technician to inspect the appliance and to replace any part of the control system and any gas control which has been underwater.
- Keep the packaging material out of reach of children and dispose of the material in a safe manner. As with all plastic bags, these are not toys and should be kept away from children and infants.
- Carbon monoxide poisoning may lead to death; early signs of carbon monoxide poisoning resemble the flu, with headache, dizziness and/or nausea. If you have these signs, the appliance may not be working properly. Get fresh air at once! Have appliance serviced. Some people; pregnant women, persons with heart or lung disease, anemia, those under the influence of alcohol, those at high altitudes are more affected by carbon monoxide than others. Failure to keep the primary air opening(s) of the burner(s) clean may result in sooting and property damage.
- As with any combustion appliance, we recommend having your appliance regularly inspected and serviced as well as having a Carbon Monoxide Detector installed in the same area to defend you and your family against Carbon Monoxide (not applicable for outdoor appliances).
- Ensure clearances to combustibles are maintained when building a mantel or shelves above the appliance. Elevated temperatures on the wall or in the air above the appliance can cause melting, discoloration or damage to decorations, a TV or other electronic components.
- **For appliances equipped with a safety barrier; if the barrier becomes damaged, the barrier shall be replaced with the manufacturer's barrier for this appliance.**
- **Installation and repair should be done by a qualified service person. It is imperative that control compartments, burners, and circulating air passageways of the appliance be kept clean.**
- For outdoor products only: this appliance must not be installed indoors or within any structure that prevents or inhibits the exhaust gases from dissipating in the outside atmosphere.

⚠ WARNING Failure to position the parts in accordance with these diagrams or failure to use only parts specifically approved with this appliance may result in property damage or personal injury.

⚠ WARNING This product can expose you to chemicals including lead and lead compounds, which are known to the State of California to cause cancer, and chemicals including carbon monoxide, which are known to the State of California to cause birth defects or other reproductive harm. For more information, go to www.P65Warnings.ca.gov.

⚠ WARNING Improper installation, adjustment, service or maintenance can cause property damage, personal injury, or loss of life. Refer to the Owner's Information manual provided with this appliance. Installation and service must be performed by a qualified installer, service agency or the gas supplier.

⚠ WARNING Vented Decorative Gas Appliance: Not a source of heat; Not for use with solid fuel. This appliance needs fresh air for safe operation and must be installed so there are provisions for adequate combustion and ventilation air.

⚠ WARNING This appliance is NOT for installation in manufactured or mobile homes.

WARNING



FIRE RISK HAZARD / DELAYED IGNITION
High supply pressure will damage the valve/controls.
 Disconnect the appliance main gas valve/control from the supply piping when pressure testing that system at pressures in excess of 1/2 psi (3.5 kPa).
 Isolate the appliance with it's shut-off valve during any pressure testing of the supply piping at pressures equal to or less than 1/2 psi (3.5 kPa).

TABLE OF CONTENTS

Warning - Safety Information.....	2-3
General Instructions and Information	5-8
Minimum Fireplace Chart	9
Parts List	10
Bill of Materials	11-13
Wiring Diagram.....	14
Pre-Installation Steps	15-16
Installation Steps	16-17
Outdoor Installation Requirements	18-19
Transmitter	20
Lighting Instructions	21-24
Troubleshooting	25-26
Warranty	27

NOTE: Changes, other than editorial, are denoted by a vertical line in the margin.

SERIAL LABEL



3515 E Atlanta Ave, Phoenix, AZ 85040
Part # 07-00085

DO NOT REMOVE THIS LABEL

See installation & operating instructions for this model.
Contact local building officials about restrictions and installation specifications in your area.

ANSI-Z21 60-2017 CSA 2.26-2

Decorative gas appliances for installation in solid-fuel burning fireplaces.

DATE OF MFG. **SERIAL #**

MODEL: 2-Burner SS: 18 21 24 30 36 42 48 60
 3-Burner SS: 18 21 24 30 36 42

MODEL: Gas: NG LP Valve: SPK MVQ MVKEI MMVR

2-Burner - BTU RATING **18"** — 52k - NG 49k - LP **21"** — 58k - NG 58k - LP **24"** — 64k - NG 64k - LP **30"** — 76k - NG 79k - LP
36" — 81k - NG 83k - LP **42"** — 86k - NG 87k - LP **48"** — 76k - NG 79k - LP **60"** — 81k - NG 83k - LP

3-Burner - BTU RATING **18"** — 46k - NG 41k - LP **21"** — 58k - NG 58k - LP **24"** — 74k - NG 64k - LP **30"** — 102k - NG 91k - LP
36" — 111k - NG 106k - LP **42"** — 120k - NG 121k - LP

NG Models
Altitude Input
Reduced Input P4
Manifold Pressure: 3.5" w.c. (NG)
Minimum Supply Pressure: 4.5" w.c. (NG)
Maximum Supply Pressure: 7" w.c. (NG)
Pression au Collecteur: .87wPA d'une colonne d'eau (GN)
Pression d'Alimentation Min.: 1.25wPA d'une colonne d'eau (GN)
Pression d'Alimentation Max.: 10.5wPA ** d'une colonne d'eau (GN) **
Maximum inlet pressure not to exceed 13".
Minimum clearance to combustible materials: Top, sides & back: per standoff spacers for framing and finishing materials. For non-combustible framing and finishing materials, see installation manual.

MANIFOLD PRESSURE:
GAS TYPE: NATURAL GAS / LIQUID PROPANE

LP Models
Élévation Alimentation / Alimentation Réduite P4
Manifold Pressure: 10" w.c. (LP)
Minimum Supply Pressure: 11" w.c. (LP)
Max. Supply Pressure: 14" w.c. (LP)
Pression au Collecteur: 2.40wPA d'une colonne d'eau (P)
Pression d'Alimentation Min.: 2.74wPA d'une colonne d'eau (P)
Pression d'Alimentation Max.: 3.49wPA * d'une colonne d'eau (P) ** Pression d'alimentation maximale ne devait pas dépasser 3.49wPA. Dégagements minimaux des matériaux combustibles: Dessus, côtés et arrière: selon les espaces de dégagements pour les matériaux d'ossature selon le manuel du propriétaire pour les matériaux de finition.

VENTED DECORATIVE GAS APPLIANCE: NOT A SOURCE OF HEAT; NOT FOR USE WITH SOLID FUEL.
APPAREIL DÉCORATIF À GAZ VENTILÉ: PAS UNE SOURCE DE CHALEUR; NE PAS UTILISER AVEC DU COMBUSTIBLE SOLIDE.

THIS APPLIANCE NEEDS FRESH AIR FOR SAFE OPERATION AND MUST BE INSTALLED SO THERE ARE PROVISIONS FOR ADEQUATE COMBUSTION AND VENTILATION AIR.
 CET APPAREIL A BESOIN D'AIR FRAIS POUR UN FONCTIONNEMENT SÉCURISÉ ET DOIT ÊTRE INSTALLÉ POUR IL Y A DES DISPOSITIONS POUR UN AIR DE COMBUSTION ET DE VENTILATION ADÉQUAT.

This is a copy of the label that accompanies this gas burner. We have printed a copy of the contents here for your review. The safety label is located near the rear of the burner. Please have your serial # handy when calling in for warranty or other reasons.

The installation, including provisions for combustion, ventilation air, and required minimum permanent vent opening, must conform with National Fuel Gas Code (ANSI Z223.1/NFPA 54) and applicable local building codes.
 L'installation, y compris les dispositions pour la combustion, l'air de ventilation et l'ouverture de ventilation permanente minimale requise, doit être conforme au National Fuel Gas Code (ANSI Z223.1 / NFPA 54) et aux codes du bâtiment locaux applicables.

⚠ WARNING: This gas appliance **must not** be connected to a chimney fuel servicing a solid fuel burning appliance.
⚠ AVERTISSEMENT: Cet appareil à gaz ne doit pas être raccordé à un combustible de cheminée desservant un appareil à combustible solide.

⚠ WARNING: THIS FIREPLACE IS NOT INTENDED FOR BURNING SOLID FUELS.
⚠ AVERTISSEMENT: CE FOYER N'EST PAS DESTINÉ À BRÛLER DES COMBUSTIBLES SOLIDES.

GENERAL INSTRUCTIONS

Damper Stop Installation

The damper must be permanently locked in position to prevent full closure and to provide a minimum flue opening. Various methods for locking the damper may be used but may be restricted from region to region and it is important to know the specifics that apply to your area. For your convenience a damper stop is provided with the appliance and may be used where not prohibited by state or local codes.

Use the 3" adjustable bolt to adjust the damper to the correct opening, based on the enclosed chart.

Should the damper stop not fit, or provide the required permanent opening from the Minimum Damper Opening table, have the damper cut to provide a minimum permanent opening or install an alternate stop.

Creosote, ashes, and loose paint must be cleaned from the chimney flue and firebox by a qualified chimney cleaner, before installing in a solid fuel burning appliance. Any outside air ducts and/or ash dumps in the fireplace shall be permanently closed at time of appliance installation.

If the damper stop (supplied) is not applicable the damper may be fixed open by the following method:

- Drill a hole in either end of the damper
- Using a bolt of sufficient length and adjustment, with 2 nuts, secure to damper through the hole
- Adjust to correct opening

Appliance must be installed only in a solid-fuel burning fireplace with a working flue and constructed of noncombustible material.

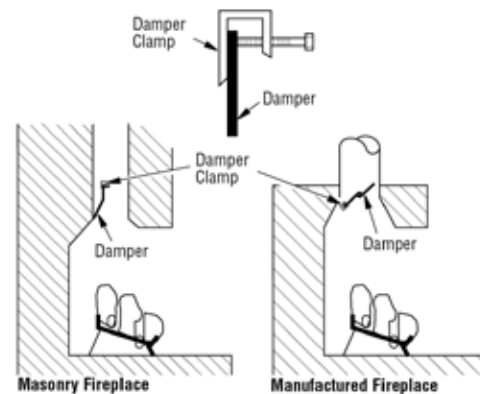

Venting Requirements

Free opening area of chimney damper for venting combustion products (factory-built fireplaces)												
Chimney Height (ft)	Appliance Input Rate (kBtu/hr)											Maximum Input
	20	30	40	50	60	70	80	90	100	110	120	
	(Minimum opening in2)											
10	11.3	16.6	22.11	28.3	35.3	44.2	-	-	-	-	-	77.6
15	8.6	12.6	17.3	21.2	26.4	32.2	38.5	45.4	-	-	-	98.2
20	7.5	10.8	14.5	18.1	22.1	26.4	31.2	37.4	43	-	-	114.2
25	6.6	9.6	12.6	15.9	18.1	22.9	27.3	31.2	36.3	43	50.3	121
30	6.2	9.1	11.3	14.5	17.3	20.4	24.6	28.3	33.2	37.4	44.2	130.1
35	5.7	8	10.8	13.2	15.9	18.9	22.1	25.5	30.2	34.2	39.6	141.2
40	5.6	7.5	10.2	12.6	15.2	18.1	20.4	23.8	27.3	31.2	35.3	158.5

Height is from hearth to top of chimney and the minimum height is 10 feet.

Chart shows some minimum opening (in 2) for the given height and input rate.

Column marked "Maximum Input" corresponds to the maximum allowable input rate (kBtu/hr) for the given height.

Free opening area of chimney damper for venting combustion products (masonry-built fireplaces)												
Chimney Height (ft)	Appliance Input Rate (kBtu/hr)											
	20	30	40	50	60	70	80	90	100	110	120	
	(Minimum opening in2)											
6	17.6	25.7	33.8	41.7	49.2	56.6	64	71.4	78.8	86.2	93.5	
8	16.5	23.7	31.2	38.7	45.5	52.4	59.7	66.9	74.1	81.3	88.6	
10	15.1	21.7	28.7	35.2	41.7	48.2	54.3	60.2	66.1	72	77.9	
15	14.1	19.9	26.1	32	37.7	43.2	48.8	54.1	59.4	64.6	69.9	
20	12.9	18.5	23.7	28.8	34.3	39.8	44.4	49.1	53.8	58.4	63	
30	12.2	16.9	21.6	26.5	31.2	35.9	40.3	44.5	48.6	52.7	56.6	

Height is from hearth to top of chimney and the minimum height is 6 feet.

Chart shows some minimum opening (in 2) for the given height and input rate.

SKU #s

**Millivolt
Natural Gas Model #
MVQMKN**

**Millivolt
Propane Model #
MVQMKLP**

**Modulating Millivolt
Natural Gas Model #
MMVR**

**Modulating Millivolt
Propane Model #
MMVR**

**Safety Pilot
Natural Gas Model #
SPQMKN**

**Safety Pilot
Propane Model #
SPQMKLP**

* These are optional valve kits that are sold separately.

GENERAL INSTRUCTIONS

LOG IDENTIFICATION

AWO18LOGS	18" Arizona Weathered Oak Logs
AWO24LOGS	24" Arizona Weathered Oak Logs
AWO30LOGS	30" Arizona Weathered Oak Logs
AWO36LOGS	36" Arizona Weathered Oak Logs
AWO42LOGS	42" Arizona Weathered Oak Logs
AJ18LOGS	18" Arizona Juniper Logs
AJ24LOGS	24" Arizona Juniper Logs
AJ30LOGS	30" Arizona Juniper Logs
AJ36LOGS	36" Arizona Juniper Logs
AJ42LOGS	42" Arizona Juniper Logs
ASPEN18LOGS	18" Quaking Aspen Logs
ASPEN24LOGS	24" Quaking Aspen Logs
ASPEN30LOGS	30" Quaking Aspen Logs
ASPEN36LOGS	36" Quaking Aspen Logs
ASPEN42LOGS	42" Quaking Aspen Logs
AWOC18LOGS	18" Arizona Weathered Oak Charred Logs
AWOC24LOGS	24" Arizona Weathered Oak Charred Logs
AWOC30LOGS	30" Arizona Weathered Oak Charred Logs
AWOC36LOGS	36" Arizona Weathered Oak Charred Logs
AWOC42LOGS	42" Arizona Weathered Oak Charred Logs
DRIFTWOOD18LOGS	18" Western Driftwood Logs
DRIFTWOOD24LOGS	24" Western Driftwood Logs
DRIFTWOOD30LOGS	30" Western Driftwood Logs
DRIFTWOOD36LOGS	36" Western Driftwood Logs
DRIFTWOOD42LOGS	42" Western Driftwood Logs

MINIMUM FIREPLACE CHART

2-BURNER STAINLESS STEEL WITH CONTROLS (SPQMKN/LP, MVQMKN/LP, MMVKR-NG/LP, EIS-N/L)	MINIMUM FIREPLACE SIZES						
	SIZE	FRONT WIDTH	DEPTH	BACK WIDTH	HEIGHT	BTU RATING NG	BTU RATING LP
	18"	30"	14"	18"	14"	52k	49k
	21"	33"	14"	21"	14"	58k	58k
	24"	36"	14"	24"	14"	64k	64k
	30"	42"	16"	30"	14"	76k	79k
	36"	48"	16"	36"	14"	81k	83k
	42"	54"	16"	42"	14"	86k	87k
	48"	60"	16"	48"	16"	150k	145k
60"	72"	16"	60"	16"	175k	165k	

3-BURNER STAINLESS STEEL WITH CONTROLS (SPQMKN/LP, MVQMKN/LP, MMVKR-NG/LP, EIS-N/L)	MINIMUM FIREPLACE SIZES						
	SIZE	FRONT WIDTH	DEPTH	BACK WIDTH	HEIGHT	BTU RATING NG	BTU RATING LP
	18"	30"	14"	18"	16"	46k	41k
	21"	33"	14"	21"	16"	58k	58k
	24"	36"	14"	24"	16"	74k	64k
	30"	42"	16"	30"	16"	102k	91k
	36"	48"	16"	36"	16"	111k	106k
	42"	54"	16"	42"	16"	120k	121k

NG PRESSURE SPECIFICATIONS

Manifold - 3.5" w.c.

Minimum - 4.5" w.c.

Maximum - 7" w.c.

LP PRESSURE SPECIFICATIONS

Manifold - 10" w.c.

Minimum - 11" w.c.

Maximum - 14" w.c.

BURNER PARTS LIST



2 Burner Stainless Steel



3 Burner Stainless Steel

Burner Kits Included:

- Burner - Pictured Above
- Lava Rock (HP-B-R-10)
- Embers (GLE-6B)
- Vermiculite - Burner Only (VEM-8)
- Whistle Free Flex Line (T202-9898-16)
- Flare Gas Inlet Fitting (46-88)
- Damper Clamp (00F0545)
- Rating Plate (02-00214)
- Rear Tines
- Manual



Rear tines are an option installation and used when you want to add more height to the fireplace log set.

*Refer to log placement in box.

MODULATING MILLIVOLT (MMVR) - BILL OF MATERIALS

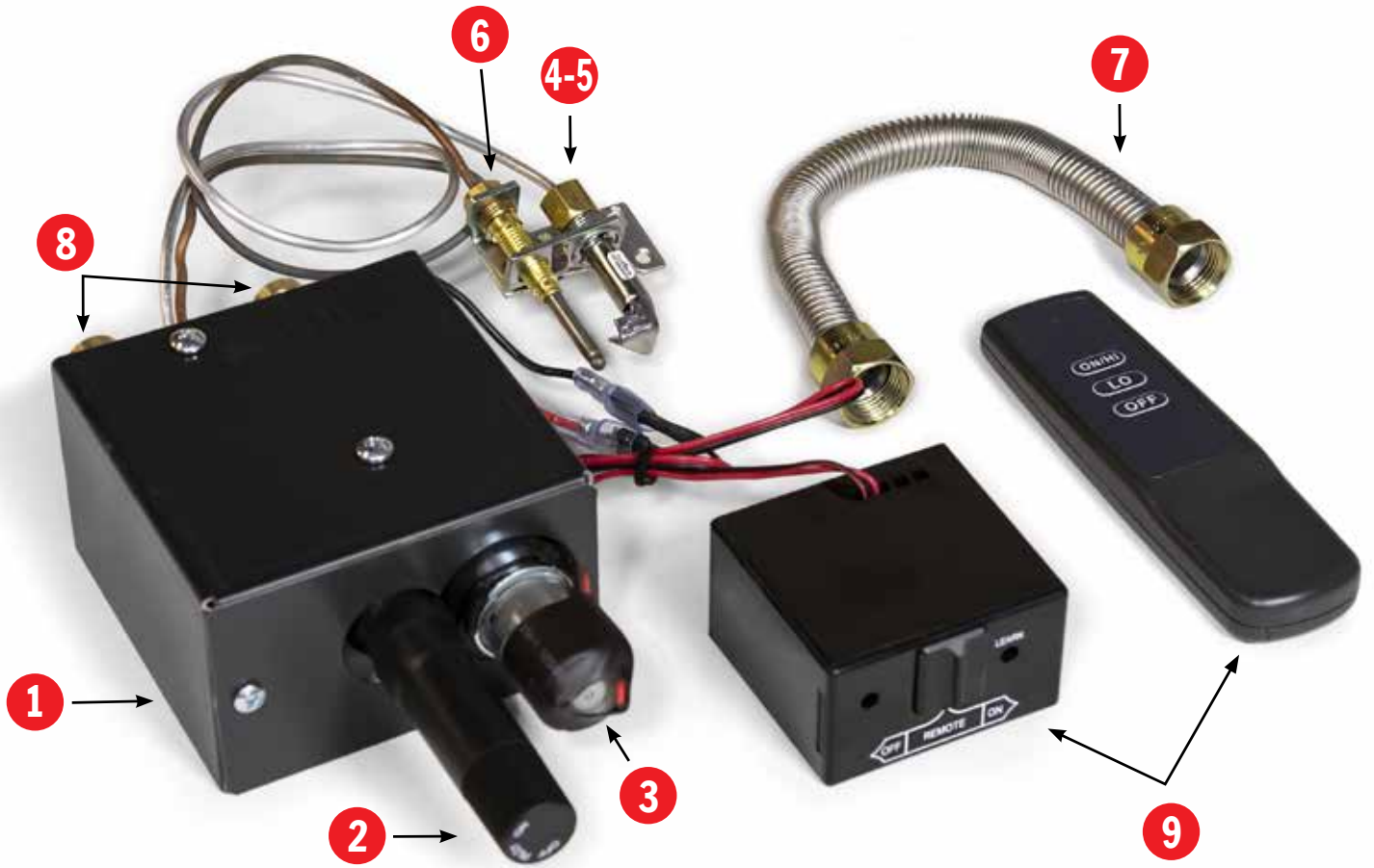

#	Model #	Description	Qty
1	AF-1000	Millivolt Valve	(1)
2	AF-2000PK-2	Pilot Knob 2" Extension	(1)
3	AF-1000MH-L	Variable Flame Motor Drive for RCAF-1021-1 Remote	(1)
4	SPK-Pilot-18	NG Pilot Assembly	(1)
5	SPK-Pilot-18P	LP Pilot Assembly	(1)
6	1900-01H	18" Thermocouple	(1)
7	T200-9898-10	Whistle Free Flex	(1)
8	48-86	1/2" Flare to 3/8" FIP	(1)
9	RCAF-1020-1	On/Off/Hi/Low Transmitter, Receiver, and Batteries	(1)

MILLIVOLT (MVQMKN/LP) - BILL OF MATERIALS

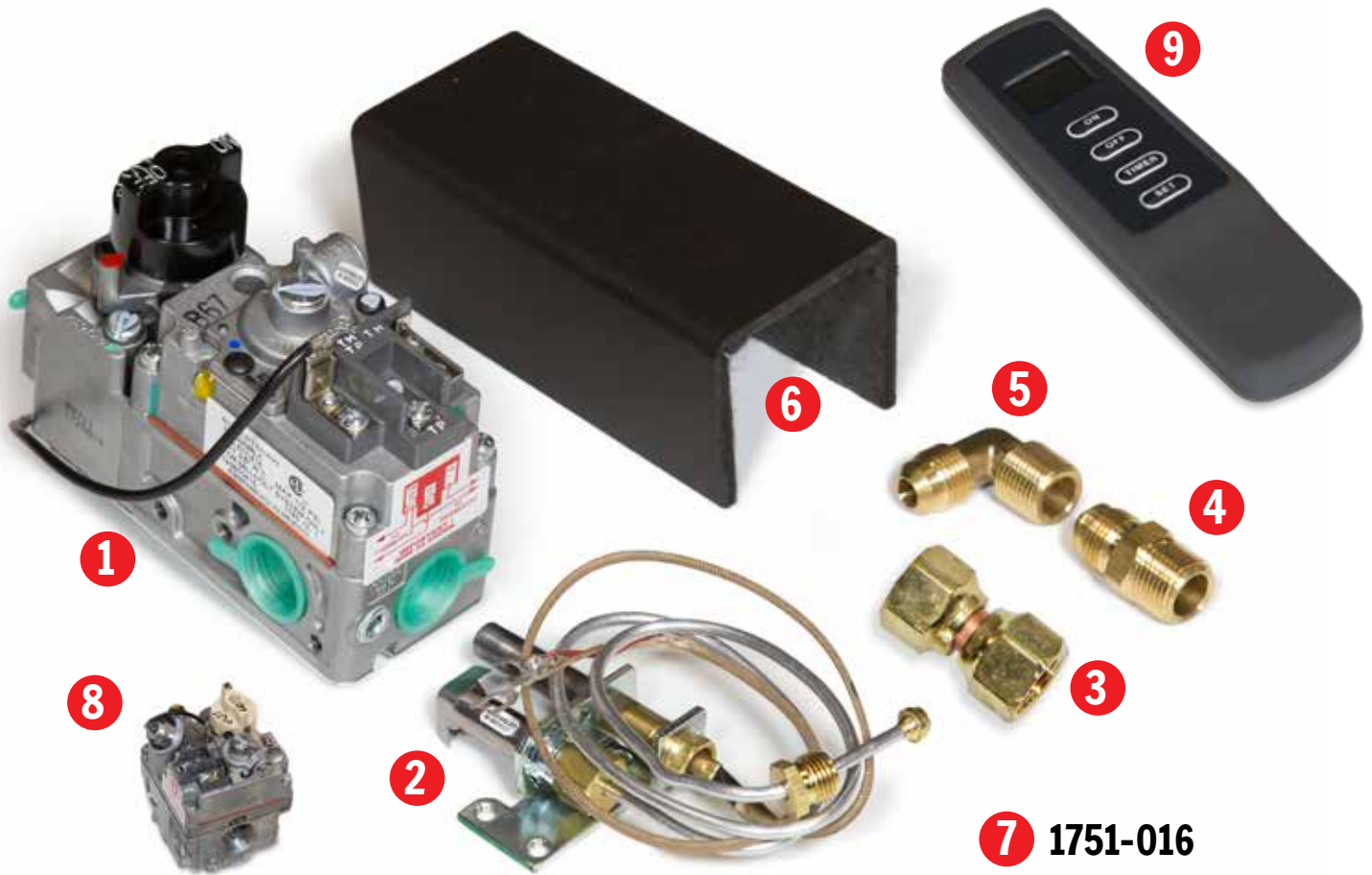

#	Model #	Description	Qty
1	710-502	MILLIVOLT VALVE	(1)
2	MV-PILOT-18	18" MILLIVOLT PILOT ASSEMBLY (NG VERSION)	(1)
2A	MV-PILOT-18P	18" MILLIVOLT PILOT ASSEMBLY (LP VERSION)	(1)
3	US-4-8	1/2" X 1/2" SWIVEL NUT UNION	(1)
4	48-88	STRAIGHT CONNECTOR 1/2" OD X 1/2" FIB	(1)
5	49-88	90° ELBOW 1/2" OD X 1/2" FIB	(1)
6	Heat Shield	MILLIVOLT HEAT SHIELD	(1)
7	1751-016	VALVE LP CONVERSION KIT (LP MODELS ONLY)	(1)
8	HCSPK-N	VALVE FOR HCMVQMKN/LP	(1)
9	GCRK	GCRK REMOTE	(1)

SAFETY PILOT (SPQMKN/LP) - BILL OF MATERIALS

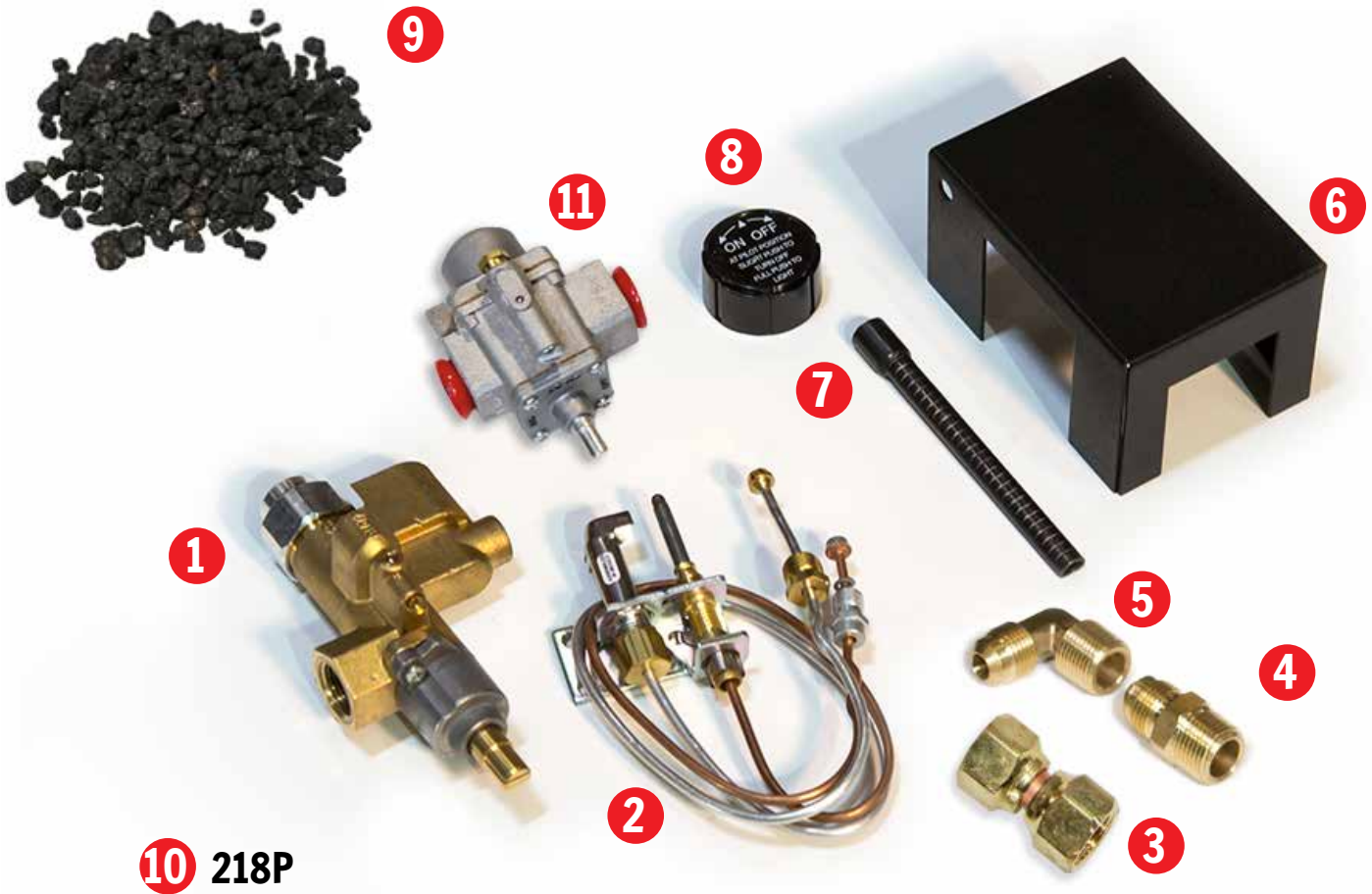

10 218P

#	Model #	Description	Qty
1		COPRECI GAS CONTROL VALVE	(1)
2	1900-01H/107	(THERMOCOUPLE PILOT HOOD)	(1)
3		1/2" X 1/2" SWIVEL NUT UNION	(1)
4	49-88	STRAIGHT CONNECTOR 1/2" OD X 1/2" FIB	(1)
5		90° ELBOW 1/2" OD X 1/2" FIB	(1)
6	HEAT SHIELD	(HEAT SHIELD)	(1)
7	101	4" STEM EXTENSION	(1)
8		CONTROL KNOB	(1)
9	VEM-8	(VERMICULITE)*	(1)
10	218P	(PILOT LP ORIFICE NOT SHOWN)*	(1)
11		HIGH CAPACITY SAFETY PILOT SYSTEM 142K BTU RATING	(1)

*LP ONLY

WARNING: Installer MUST follow gas flow the valve. If not valve may not shut off gas.

WIRING DIAGRAM

MILLIVOLT

Wire Size	Wire Length	Wire Size	Wire Length
14 GA.	100 FT.	20 GA.	25 FT.
16 GA.	64 FT.	22 GA.	16 FT.
18 GA.	40 FT.		

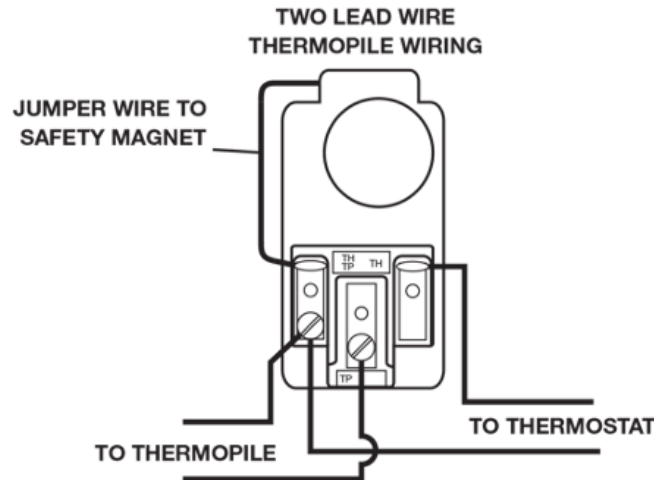

Before you begin

Thank you for purchasing Grand Canyon Gas Log's **2 Burner Stainless Steel / 3 Burner Stainless Steel**. This product has been designed to provide you with safe, trouble-free operation.

Please read this manual thoroughly before beginning the installation. It has information which is important for safe installation and operation.

Please inspect your shipment for completeness and any damage. Contact your retailer if any damage is found. Do not install your appliance with any damage or substituted parts.

The installation of your **2 Burner Stainless Steel / 3 Burner Stainless Steel** will follow the steps listed:

- Pre-Installation planning - ensure the opening of the fireplace meets the specification
- Gas installation (Preferred left side)
- Installing the burner
- Media and log placement

Before you begin the installation you should have the following tools and supplies:

- Pipe wrenches
- Safety glasses and gloves
- Approved pipe joint sealant
- Manometer
- Leak detection fluid (noncorrosive) or electronic gas detector
- Appropriate gas supply line parts

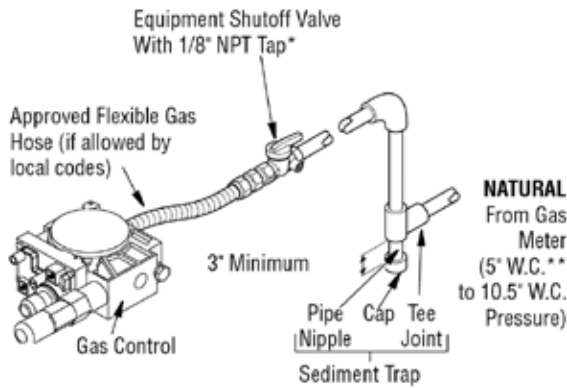

* Purchase the optional equipment shutoff valve from your dealer.
 ** Minimum inlet pressure for purpose of input adjustment.

Figure B - Gas Connection

Install in piping system between fuel supply and appliance. Locate sediment trap where trapped matter is not likely to freeze. A sediment trap traps moisture and contaminants. This keeps them from going into appliance controls. If sediment trap is not installed or is installed wrong, appliance may not run properly.

CAUTION: Avoid damage to gas control. Hold gas control with wrench when connecting it to gas piping and/or fittings.

CHECKING GAS CONNECTIONS

WARNING: Test all gas piping and connections, internal and external to unit, for leaks after installing or servicing. Correct all leaks at once.

WARNING: Never use an open flame to check for a leak. Apply a noncorrosive leak detection fluid to all joints. Bubbles forming show a leak. Correct all leaks at once.

PRESSURE TESTING GAS SUPPLY PIPING SYSTEM

The appliance and its appliance main gas valve must be disconnected from the gas supply piping system during any pressure testing of that system at test pressures **in excess of** 1/2 psi (3.5 kPa). The appliance must be isolated from the gas supply piping system by closing its equipment shut-off valve during any pressure testing of the gas supply piping system at test pressures **equal to or less than** 1/2 psi (3.5 kPa).

Test Pressures In Excess Of 1/2 PSIG (3.5 kPa)

1. Disconnect appliance with its appliance main gas valve (control valve) and equipment shut-off valve from gas supply piping system. Pressures in excess of 1/2 PSIG will damage appliance regulator.
2. Cap off open end of gas pipe where equipment shut-off valve was connected.
3. Pressurize supply piping system by opening main gas valve located on or near gas meter for natural gas or using compressed air.
4. Check all joints of gas supply piping system. Apply noncorrosive leak detection fluid to all joints. Bubbles forming show a leak.
5. Correct all leaks at once.
6. Reconnect appliance and equipment shut-off valve to gas supply. Check reconnected fittings for leaks.

Test Pressures Equal To or Less Than 1/2 PSIG (3.5 kPa)

1. Close equipment shut-off valve (see Figure C).
2. Pressurize supply piping system by opening main gas valve located on or near gas meter for natural gas or using compressed air.
3. Check all joints from gas meter to equipment shut-off valve for natural gas. Apply noncorrosive leak detection fluid to all joints bubbles forming show a leak.
4. Correct all leaks at once.

PRESSURE TESTING APPLIANCE GAS CONNECTIONS

1. Open equipment shut-off valve.
2. Open main gas valve located on or near gas meter for natural gas.
3. Make sure control knob of appliance is in the OFF position.
4. Check all joints from gas meter to equipment shut-off valve for natural gas. Apply noncorrosive leak detection fluid to all joints. Bubbles forming show a leak.
5. Correct all leaks at once.
6. Light appliance. Check all other internal joints for leaks.
7. Turn off appliance.

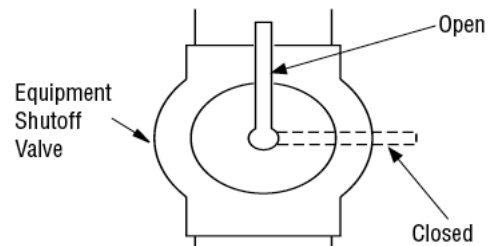

Equipment Shut-off Valve

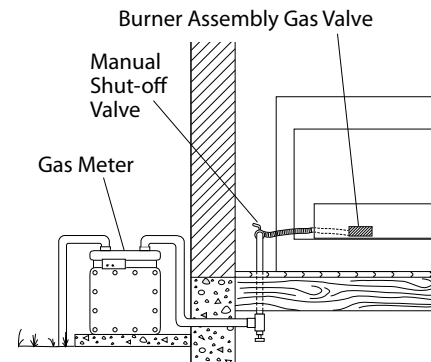

Checking Gas Joints (Natural Gas Only)

We recommend that you install a sediment trap in supply line as shown in Figure C. Locate sediment trap where it is within reach for cleaning.

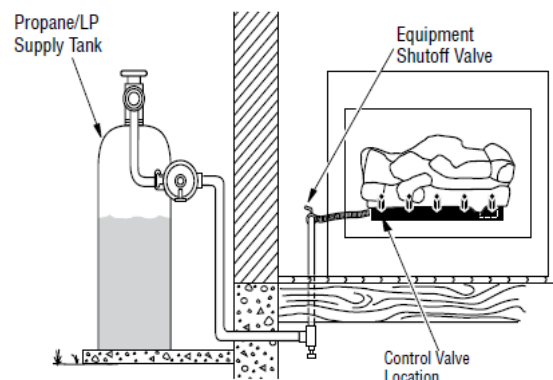

Figure C - External Regulator with Vent Pointing Down

PRE-INSTALLATION / INSTALLATION

For Massachusetts Residents Only: Installation of this gas log set as a vented indoor appliance in the Commonwealth of Massachusetts requires the damper be permanently removed or welded in the fully open position.

You must install the damper clamp accessory. This will ensure vented operation. The damper clamp will keep damper open.

For minimum permanent flue opening you must provide. Attach damper clamp so the minimum permanent flue opening will be maintained at all times.

CONNECTING TO GAS SUPPLY

⚠ WARNING: This appliance requires a 1/2" NPT (National Pipe Thread) inlet connection to the pressure regulator.

⚠ WARNING: A qualified service person must connect appliance to gas supply. Follow all local codes.

⚠ WARNING: *Never connect this appliance to private (non-utility) gas wells. This gas is commonly known as wellhead gas and does not have odorants and may have impurities, and variations in BTU content. The use of wellhead gas will void the manufacturer's warranty to this appliance.*

When an appliance is for connection to a fixed piping system, the installation must conform with local codes, or in the absence of local codes with the National Fuel Gas Code, ANSI Z223.1 • NFPA 54; National Fuel Gas Code.

⚠ CAUTION: Use only new, black iron, or steel pipe. Internally-tinned copper tubing may be used in certain areas. Check your local codes. Use pipe of 1/2" diameter or greater to allow proper gas volume to appliance. If pipe is too small, undue loss of volume will occur.

Installation must include an equipment shut-off valve, union and plugged 1/8" NPT tap. Locate NPT tap within reach for test gauge hook up. NPT tap must be upstream from appliance.

IMPORTANT: Install equipment shut-off valve in an accessible location. The equipment shut-off valve is for turning on or shutting off the gas to the appliance.

Check your building codes for any special requirements for locating equipment shut-off valve to appliances.

Apply pipe joint sealant lightly to male NPT threads. This will prevent excess sealant from going into pipe. Excess sealant in pipe could result in clogged appliance valves.

INSTALLATION

⚠ WARNING: Glass doors shall be fully open when appliance is in operation.

CLEANING AND MAINTENANCE

⚠ WARNING: Turn off appliance and let cool before cleaning.

⚠ CAUTION: You must keep control areas, burners and circulating air passageways of appliance clean. Inspect these areas of appliance before each use. Have appliance inspected yearly by a qualified service person.

⚠ WARNING: Failure to keep the primary air opening(s) of the burner(s) clean may result in sooting and property damage.

BURNER INJECTOR HOLDER AIR INLET HOLE

The primary air inlet holes allow the proper amount of air to mix with the gas. Keep these holes clear of dust, dirt, lint, and pet hair. Clean these air inlet holes prior to each heating season. Blocked air holes will create soot. We recommend that you clean the unit every three months during operation and have appliance inspected yearly by a qualified service person.

We also recommend that you keep the burner tube clean and free of dust and dirt. To clean these parts we recommend using compressed air not greater than 30 PSI. Your local computer store, hardware store or home center may carry compressed air in a can. If you don't follow directions on the can, you could damage the pilot assembly.

1. Shut off unit. Allow unit to cool for at least thirty minutes.
2. Inspect burner, and primary air inlet holes on injector holder for dust and dirt.
3. Blow air through the ports/slots and holes in the burner.

4. Check injector holder located at end of burner tube again. Remove any large particles of dust, dirt, lint or pet hair with a soft cloth or vacuum cleaner nozzle.
5. Blow air into the primary air holes on the injector holder.
6. In case any large clumps of dust have now been pushed in the burner repeat steps 3 and 4. Additional cleaning may be needed for proper operation based on use/lack of use.

LOGS

- If you remove logs for cleaning, refer to installing logs and media placement to properly replace logs.
- Replace log(s) if broken or chipped (dime size or larger).

MAIN BURNER

Periodically inspect all burner flame holes with appliance running. All slotted burner flame holes should be open with flame present. All round burner flame holes should be open with a small blue flame present. Some burner flame holes may become blocked by debris or rust, with no flame present. If so, turn off appliance and let cool. Remove blockage, blocked burner flame holes will create soot. The burner must be replaced prior to the appliance being put into operation if it is evident that the burner is damaged (use only factory original replacement burner).

At least once a year, the vent system for the fireplace in which this appliance is installed shall be inspected, cleaned, and repaired as necessary by a qualified service person.

DECORATIVE MEDIA INSTALLATION (BLACK EMBERS/LAVA ROCK)

1. Place the black glowing embers (supplied with burner) heavily and evenly in the areas shown (Figure 5). Break up black embers to be no larger than the size of a dime. Store any excess embers if applicable.
2. Spread the supplied lava rock (Figure 6) on the floor of the fireplace, around the front and sides of the burner system. The lava rocks may be placed around the receiver/battery box. Leave the front of the receiver/battery box clear for control access.



Figure 5 - Embers



Figure 6 - Lava Rock

OUTDOOR INSTALLATION REQUIREMENTS

2 Burner Stainless Steel / 3 Burner Stainless Steel from Grand Canyon Gas Logs have been tested and approved for installation outdoors under a patio cover and away from direct water contact or direct sunlight. Grand Canyon Gas Logs standard warranty applies if installed per instructions. All electrical wiring shall be to local building codes. Consult professional installers before installation. Approved installations are as noted below.

Front Protection:

Patio roof overhang must be 50% (or more) of the height of the patio roof from bottom of fireplace.

If: $H=6'$

Then: $OD=3'$ minimum ($6' \times 50\%=3'$)

Note 1: Base of fireplace must be 2" (minimum) above floor.

Note 2: H taken from bottom of fireplace.

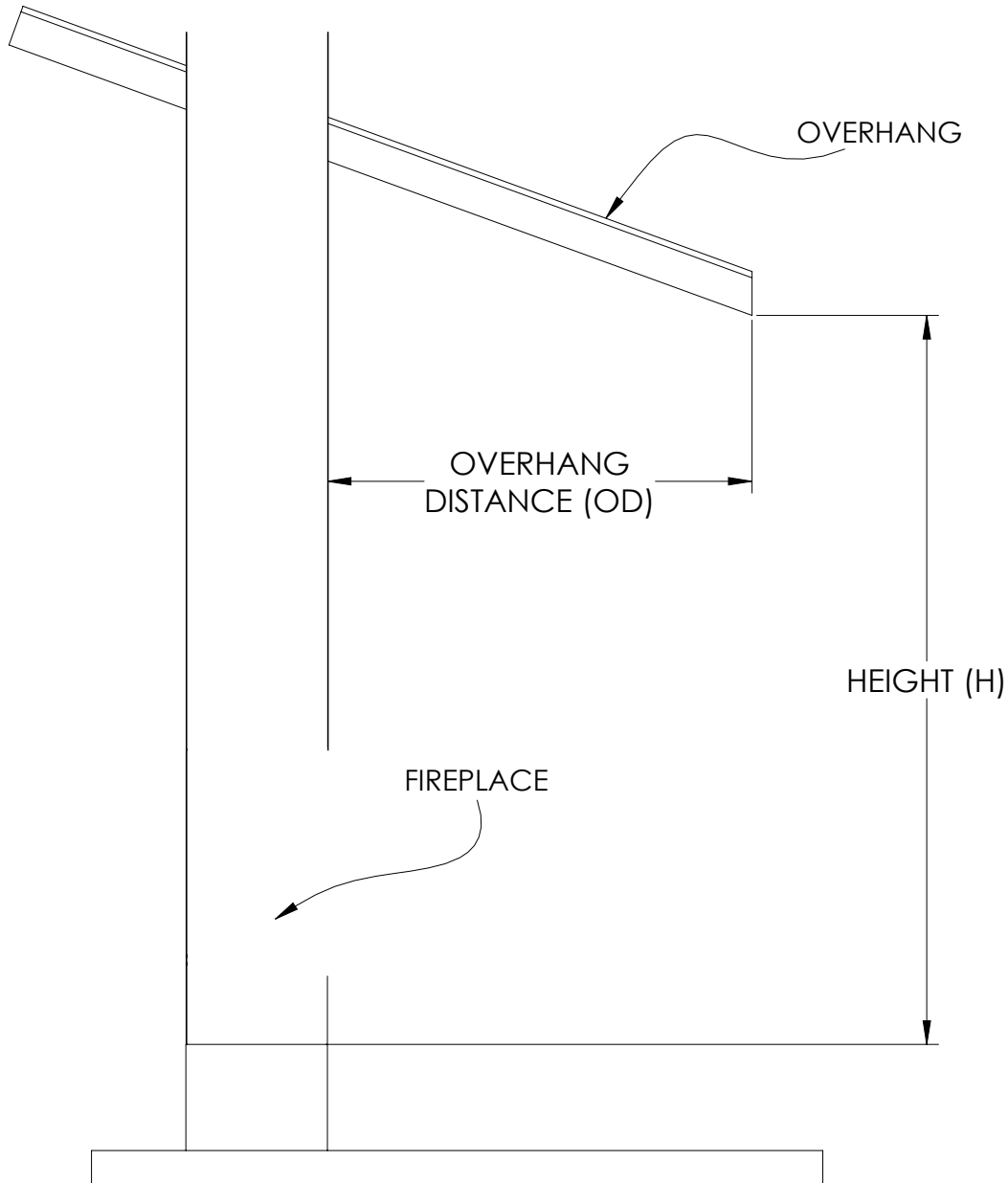

OUTDOOR INSTALLATION REQUIREMENTS

Side Protection:

Side distance (SD) must be 50% (or more) of the height (H).

If: $H=6'$

Then: $SD=3'$ minimum ($6' \times 50\%=3'$)

Note: H taken from bottom of fireplace.

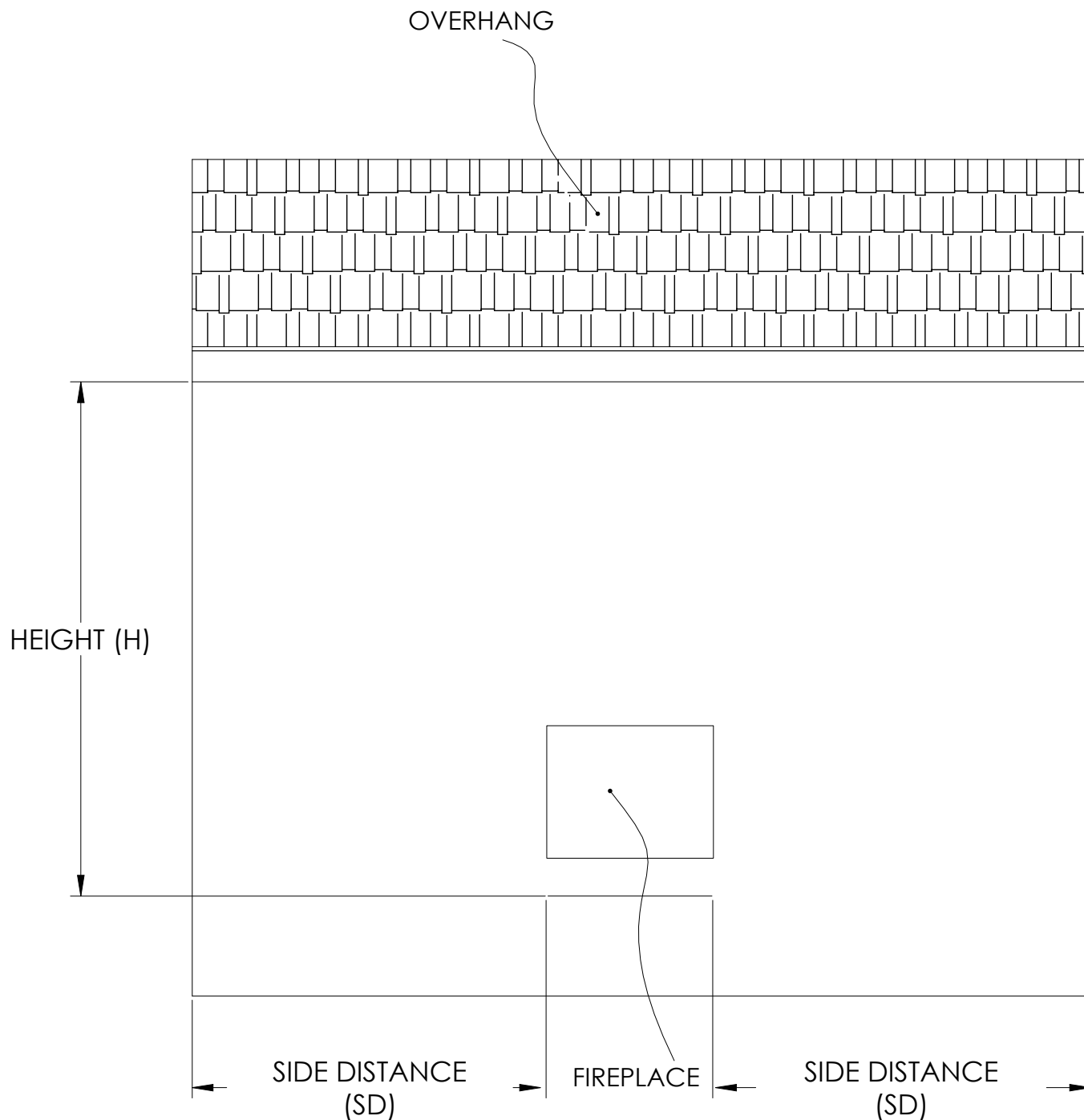

TRANSMITTER

TRANSMITTER

The transmitter operates on (2) 1.5V AAA batteries. It is recommended that ALKALINE batteries always be used for this product. Be sure the batteries are installed with the (+) and (-) ends facing the correct direction, and are fully charged.

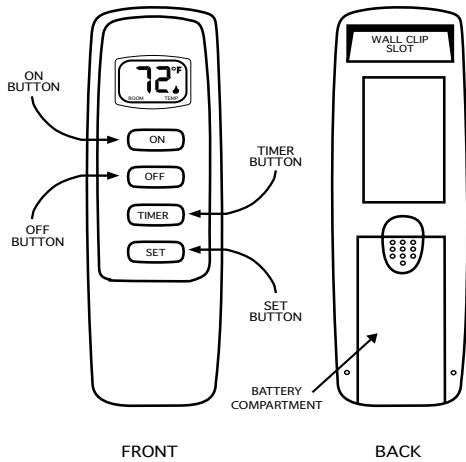

KEY SETTINGS

1. ON – Turns appliance ON
2. OFF – Turns appliance OFF
3. TIMER – Changes unit from manual mode to timer mode
4. SET – Adjust timer setting

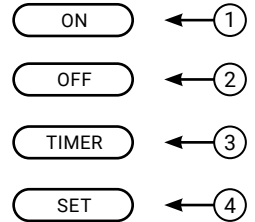

LCD-LIQUID CRYSTAL DISPLAY

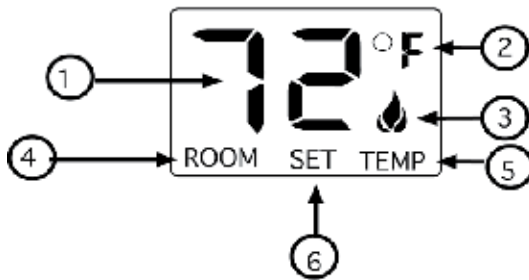

1. Display – Indicates current room temperature
2. Fahrenheit or Celsius – Indicates degrees Fahrenheit or Celsius
3. Flame – Indicates appliance is ON
4. Room – Appears when LCD screen is ON
5. Temperature – Appears during manual operation
6. Set – Appears when adjusting the desired timer settings

SETTING °FAHRENHEIT/°CELSIUS SCALE

The factory setting for temperature is °F. To change the displayed temperature scale, press the ON and OFF keys at the same time. Follow this same procedure to return to °F.

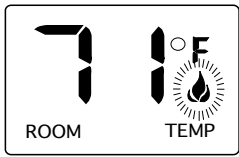
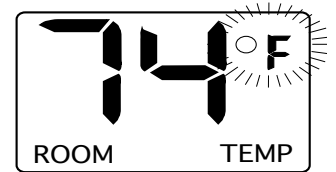

ON MODE

MANUAL FUNCTION

ON OPERATION:

Press the on key to turn the appliance on. (The flame icon will appear on the LCD screen).

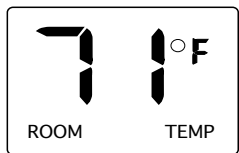

OFF MODE

OFF OPERATION:

Press the OFF key to turn the appliance OFF. (The flame icon will disappear from the LCD screen).

TIMER FUNCTION

- Press the ON button to start the appliance.
- Press the TIMER button. The LCD screen will show the word set.
- Press the SET button until the desired time is reached (15 min. - 180 min. in 15 minute increments). The ax setting tie is 3 hours.
- NOTE: The LCD display will flash the set time for 6-seconds, then start the countdown.
- Press the OFF button to turn OFF the timer, and the appliance.



SET MODE

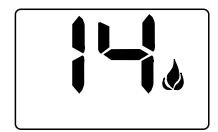

COUNT DOWN MODE

LEARNING TRANSMITTER TO RECEIVER

Each transmitter uses a unique security code. It will be necessary to press the **LEARN** button on the receiver to accept the transmitter security code upon initial use, if batteries are replaced, or if a replacement transmitter is purchased from your dealer or the factory. In order for the receiver to accept the transmitter security code, be sure the side button on the receiver is the **REMOTE** position; the receiver will not **LEARN** if the slide switch is in the **ON** or **OFF** position. The **LEARN** button is located on the front face of the receiver; inside the small hole labeled **LEARN**. Using a small screwdriver or end of a paperclip gently press and release the black **LEARN** button inside the hole. When you release the **LEARN** button the receiver will emit an audible "beep". After the receiver emits the beep press the transmitter **ON** button and release. The receiver will emit several beeps indicating that the transmitter's code has been accepted in the receiver.

FOR YOUR SAFETY READ BEFORE LIGHTING

"WARNING - If you do not follow these instructions exactly, a fire or explosion may result causing property damage, personal injury or loss of life.



- A. This appliance has a pilot which must be lighted by hand.
- B. **BEFORE LIGHTING** smell all around the appliance area for gas. Be sure to smell next to the floor because some gas is heavier than air and will settle on the floor.
WHAT TO DO IF YOU SMELL GAS
 1. Do not try to light any appliance.
 2. Do not touch any electric switch; do not use any phone in your building.
 3. Immediately call your gas supplier from a neighbor's phone. Follow the gas supplier's instructions.
 4. If you cannot reach your gas supplier, call the fire department.
- C. Use only your hand to push in or turn the gas control knob. Never use tools. If the knob will not push in or turn by hand, don't try to repair it, call a qualified service technician. Force or attempted repair may result in a fire or explosion.
- D. Do not use this appliance if any part has been underwater. Immediately call a qualified service technician to inspect the appliance and to replace any part of the control system and any gas control, which has been underwater.

LIGHTING INSTRUCTIONS

1. STOP! Read the safety information above on this label.
2. Push in gas control knob slightly and turn clockwise to "OFF." 
4. Find pilot - follow metal tube from the gas control behind the burner.





NOTE: Knob cannot be turned from "PILOT" to "OFF" unless knob is pushed in slightly. Do not force.

3. Wait five (5) minutes to clear out any gas. If you then smell gas. If you then smell gas, STOP! Follow "B" in the safety information above. If you don't smell gas, go to next step.
5. Turn knob on gas counter-clockwise to arrow in the center of the knob.
6. Push in control knob all the way and hold in. Immediately light the pilot with a match. Continue to hold the control knob in for about one minute after the pilot is lit. Release knob and it will pop back up. Pilot should remain lit. If it goes out, repeat steps 3-7.
 - If knob does not pop up when released, stop and immediately call your service technician or gas supplier.
 - If the pilot will not stay lit after several tries, turn the gas control knob to "OFF"  and call your service technician or gas supplier.
7. Turn gas control knob counterclockwise to "ON." 



TO TURN OFF GAS TO APPLIANCE

1. Turn knob clockwise from "ON"  position to the center arrow position. Push in the gas control knob slightly and turn clockwise to "OFF."  Do not force knob.

FOR YOUR SAFETY - LIGHTING INSTRUCTIONS

“WARNING – If you do not follow these instructions exactly, a fire or explosion may result causing property damage, personal injury or loss of life.”

- A. This appliance has a pilot which must be lighted by hand.
 - B. BEFORE LIGHTING smell all around the appliance area for gas. Be sure to smell next to the floor because some gas is heavier than air and will settle on the floor.
- WHAT TO DO IF YOU SMELL GAS:
1. Do not try to light any appliance.
 2. Do not touch any electric switch; do not use any phone in your building.
 3. Immediately call your gas supplier from a neighbor’s phone. Follow the gas supplier’s instructions.
 4. If you cannot reach your gas supplier, call the fire department.
 5. Use only your hand to push in or turn the gas control knob. Never use tools. If the knob will not push in or turn by hand, don’t try to repair it, call a qualified service technician. Force or attempted repair may result in a fire or explosion.
 6. Do not use this appliance if any part has been underwater. Immediately call a qualified service technician to inspect the appliance and to replace any part of the control system and any gas control, which has been underwater.

LIGHTING INSTRUCTIONS FOR MILLIVOLT VALVE

1. STOP! Read the safety information above on this label.
2. Push in gas control knob slightly and turn clockwise to **“OFF.”**

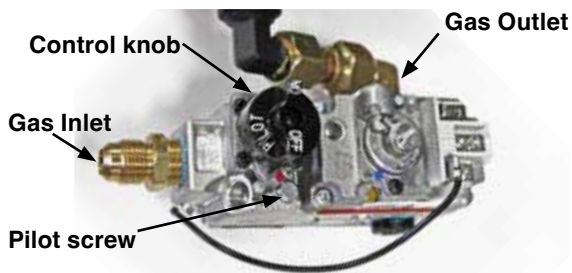

NOTE: Knob cannot be turned from ‘PILOT’ to ‘OFF’ unless knob is pushed in slightly. Do not force.

3. Wait five (5) minutes to clear out any gas. If you smell gas, STOP! Follow “B” in the safety information above. If you don’t smell gas, go to next step.
4. Find pilot – follow metal tube from the gas control behind the burner.
5. Turn knob on gas control-clockwise to **“PILOT.”**

6. Push in control knob all the way and hold in immediately light the pilot with a match. Continue to hold the control knob in for about one minute after the pilot is lit. Release knob and it will pop back up. Pilot should remain lit. If it goes out, repeat steps 3-7.

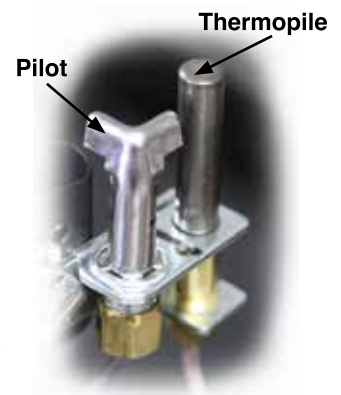

- If knob does not pop up when released, stop and immediately call your service technician or gas supplier.
 - If the pilot will not stay lit after several tries, turn the gas control knob to “OFF” and call your service technician or gas supplier.
7. Turn gas control knob counterclockwise to **“ON.”**

TO TURN OFF GAS TO APPLIANCE

1. Turn knob clockwise from **“ON”** position to the **“PILOT”** position. Push in the gas control knob slightly and turn clockwise to **“OFF.”** Do not force knob.

PROCEDURE FOR LIGHTING OR RELIGHTING

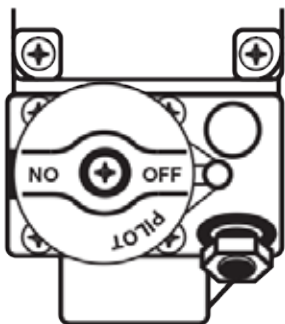

“OFF” POSITION

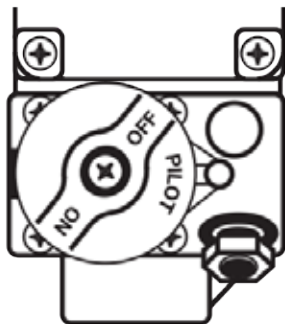

“PILOT” POSITION

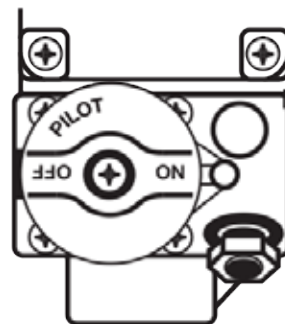

“ON” POSITION

Dials must be operated by hand. DO NOT use pliers, wrenches, or other tools to turn dials.

The Gas Cock Dial has a dual function:

- A) Complete control of gas to pilot and main burner.
- B) When in pilot position, it is the reset mechanism for the automatic pilot.

The Gas Cock Dial cannot be turned to “OFF” position without first depressing dial in “PILOT” position and then rotating to “OFF.”

1. Depress and turn Gas Cock Dial to “OFF” position.
2. Turn temperature dial (hydraulic models) or wall thermostat (24V and millivolt models) to “OFF” or lowest setting.
3. Wait at least 5 minutes (10 minutes for L.P. gas) to allow gas which may have accumulated in burner compartment to escape.

4. Turn Gas Cock Dial to the “PILOT” position.

5. Hold match at pilot burner. **CAUTION:** If pilot lights without depressing Gas Cock Dial replace control. Depress and hold Gas Cock Dial while lighting pilot burner. Allow pilot to burn approximately one half minute. (1-1/2 minutes for millivolt models) before releasing Gas Cock Dial. If pilot does not remain lighted, repeat operation allowing longer period before releasing Gas Cock Dial. (Adjust pilot, if necessary, as noted under “Pilot Burner Adjustment.”) The thermocouple or thermopile may also be defective and should be checked out. (See SERVICE INSTRUCTIONS).

LEAK TEST

Test for gas leaks after valve installation with main burner on. Use a rich soapy water, and paint all piping and tubing joints liberally. Bubbles are indicative of a leak.

MODULATING MILLIVOLT - LIGHTING INSTRUCTIONS

FOR YOUR SAFETY READ BEFORE LIGHTING

WARNING: If you do not follow these instructions exactly, a fire or explosion may result causing property damage, personal injury or loss of life.

A. This appliance has a pilot, which must be lit by hand. When lighting the pilot, follow these instructions exactly.

B. BEFORE LIGHTING smell all around the appliance area for gas. Be sure to smell next to floor because some gas is heavier than air and will settle on the floor.

WHAT TO DO IF YOU SMELL GAS

1. Do not try light any appliance.
2. Do not touch any electric switch: do not use any phone in your building.
3. Immediately call your gas supplier from a neighbor's phone. Follow the gas supplier's instructions.
4. If you cannot reach your gas supplier, call the fire department.

C. Use only your hand to push in or turn the gas control knob. Never use tools. If the knob will not push in or turn by hand, do not try to repair it. Call a qualified service technician.

D. Do not use this appliance if any part has been underwater. Immediately call a qualified service technician to inspect the appliance and to replace any part of the control system and any gas control, which has been underwater.

LIGHTING INSTRUCTIONS FOR SKC VALVE

1. STOP! Read the safety information above on this label.
2. Push in control knob slightly and turn clockwise to "OFF." 





NOTE: Knob cannot be turned from "PILOT" to "OFF" unless knob is pushed in slightly. Do not force.

3. Wait five (5) minutes to clear out any gas. If you then smell gas, STOP! Follow "B" in the safety information above. If you don't smell gas, go to next step.

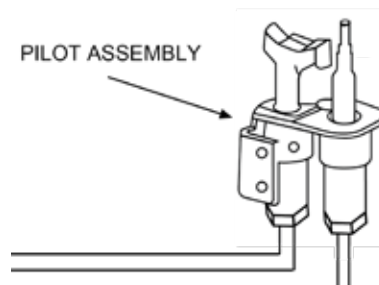
4. Find pilot – follow metal tube from the gas control behind the burner pan.



5. Turn knob on gas control counterclockwise to "PILOT." 
6. Push in control knob all the way and hold in. Immediately light the pilot with a match. Continue to hold the control knob in for about one minute after the pilot is lit. Release knob and it will pop back up. Pilot should remain lit. If it goes out, repeat steps 3 – 7.
 - * If knob does not pop up when released, stop and immediately call your service technician or gas supplier.
 - * If the pilot will not stay lit after several tries, turn the gas control knob to "OFF" and call your service technician or gas supplier.
7. Turn gas control knob counterclockwise to "ON." 
8. Use Remote Control or Wall Switch to adjust main burner flame height

TO TURN OFF GAS TO APPLIANCE

1. Turn knob clockwise from "ON" position to the "PILOT" position. Push in the gas control knob slightly and turn clockwise to "OFF."  Do not force knob.

⚠ WARNING: Turn off appliance and let cool before servicing. Only a qualified service person should service and repair appliance.

NOTE: All troubleshooting items are listed in order of operation.

Symptom	Problem	Test Solution
Delayed ignition of burner	<ol style="list-style-type: none"> 1. Manifold pressure is too low. 2. Burner orifice clogged. 	<ol style="list-style-type: none"> 1. Contact local natural or propane/LP gas company. 2. Clean burner or replace burner orifice(s).
Burner backfiring during combustion	<ol style="list-style-type: none"> 1. Burner orifice is clogged or damaged. 2. Damaged burner. 	<ol style="list-style-type: none"> 1. Clean burner or replace burner orifice. 2. Replace damaged burner.
Slight smoke or odor during initial operation	<ol style="list-style-type: none"> 1. Residues from manufacturing processes and logs curing. 	<ol style="list-style-type: none"> 1. Problem will stop after a few hours of operation.
Appliance produces a whistling noise when burners are lit	<ol style="list-style-type: none"> 1. Air in gas line 2. Air passage ways on appliance blocked. 3. Dirty or partially clogged burner orifice. 4. Flex line has kink. 	<ol style="list-style-type: none"> 1. Operate burners until air is removed from line. Have a gas line checked by local natural or propane/LP gas company. 2. Observe minimum installation clearances. 3. Clean burner or replace burner orifice(s). 4. Straighten flexible connector.
White powder residue forming within burner box or on adjacent walls or furniture	<ol style="list-style-type: none"> 1. When heated, vapors from furniture polish, wax, carpet cleaners, etc. may turn into white powder residue. 	<ol style="list-style-type: none"> 1. Turn appliance off when using furniture polish, wax, carpet cleaners, or similar products.
Remote does not function	<ol style="list-style-type: none"> 1. Batteries are not installed. Battery power is low. 	<ol style="list-style-type: none"> 1. Replace batteries in battery pack and in hand held remote.

TROUBLESHOOTING

⚠️ WARNING: If you smell gas

- Shut off gas supply.
- Do not try to light any appliance.
- Do not touch any electrical switch; do not use any phone in your building.
- Immediately call your gas supplier from a neighbor's phone. Follow the gas supplier's instructions.
- If you cannot reach your gas supplier, call the fire department.

IMPORTANT: Operating appliance where impurities in air exist may create odors. Cleaning supplies, paint, paint remover, cigarette smoke, cements and glues, new carpet or textiles, etc., create fumes. These fumes may mix with combustion air and create odors. These odors will disappear over time.

Symptom	Problem	Test Solution
Appliance produces unwanted odors	<ol style="list-style-type: none"> 1. Appliance burning vapors from paint, hair spray, glues cleaners, chemicals new carpet, etc. (See IMPORTANT statement above). 2. Low fuel supply (propane/LP only). 3. Gas leak. See Warning: If you smell gas statement above. 	<ol style="list-style-type: none"> 1. Open window to ventilate room. Stop using odor causing products while appliance is running. 2. Refill supply tank (propane/LP only). 3. Locate and correct all leaks.
Appliance shuts off in use	<ol style="list-style-type: none"> 1. Low line pressure. 	<ol style="list-style-type: none"> 1. Contact local natural or propane/LP gas company.
Millivolt Appliance shuts off in use	<ol style="list-style-type: none"> 1. Dirty or bad thermopile. 	<ol style="list-style-type: none"> 1. Clean thermopile w/ sandpaper or brass brush. Replace thermopile.
Gas odor even when control knob is in OFF position	<ol style="list-style-type: none"> 1. Gas leak. See Warning: If you smell gas statement above. 2. Control valve or gas control defective. 	<ol style="list-style-type: none"> 1. Locate and correct all leaks.
Gas odor during combustion	<ol style="list-style-type: none"> 1. Gas leak. See Warning: If you smell gas statement above. 	<ol style="list-style-type: none"> 1. Locate and correct all leaks.
Battery Electronic System is turned ON but not sparking	<ol style="list-style-type: none"> 1. Weak batteries or bad AC adapter. 2. A Shorted or loose connection in the wiring configuration or wire harness. 	<ol style="list-style-type: none"> 1. Replace batteries. 2. Verify wiring per wiring diagram. 3. Verify wiring per wiring diagram. 4. Replace module.
Battery Electronic Pilot lights but the system continues to spark	<ol style="list-style-type: none"> 1. Poor flame rectification or contaminated sensor rod. 2. Module is not grounded. 3. Damaged pilot assembly. 4. Too large of a gap in sensor rod. 	<ol style="list-style-type: none"> 1. Clean sensor rod. 2. Verify wiring. 3. Replace pilot assembly. 4. Verify sensor rod needs to have a 1/8" gap.
Appliance produces a clicking/ticking noise just after burners are lit or shut off	<ol style="list-style-type: none"> 1. Metal expanding while heating or contracting while cooling. 2. Igniter assembly is out of position. 3. Wind is disturbing the burner flame and the igniter assembly is relighting the burner. 4. Wire connection loose or wire broken. 	<ol style="list-style-type: none"> 1. This is normal with most appliances. If noise is excessive, contact qualified service person. 2. Check igniter position and adjust if needed. 3. Should wind disturb the burner flame, the igniter will automatically spark to relight the burner. This is normal when the appliance is installed outdoors in windy conditions. 4. Check wiring connections. Replace wire harness if necessary.

Burner:

Grand Canyon Gas Logs burners carry a life time warranty against manufacture defects or breakage as long as the appliance is installed inside and by a professional installer. In the event a defect or breakage occurs a replacement will be available for pick up from the dealer at which the burner was originally purchased. This warranty is limited to original purchaser only. Indoor burners installed outside carry a (1) year warranty.

Electrical and Valves:

Grand Canyon Gas Logs valves, remotes, and receivers carry a (2) year warranty against breakage or defects from date of purchase, by original purchaser, and must be installed by a licensed professional installer. This warranty only covers use with Grand Canyon Gas Logs burners and logs. In the event a defect or breakage occurs a replacement will be available for pick up from the dealer at which the burner was originally purchased. Batteries are not covered under this warranty. ODS pilot assemblies carry a (1) year warranty.

Refractory Logs:

Grand Canyon Gas Logs, logs carry a lifetime warranty against any manufacture defects or breakage as long as the products are installed INDOORS. Logs installed in an outdoor fireplace or outdoor firepits carry a (5) year warranty. This warranty does not cover color fading due to use. In the event defect or breakage occurs, a replacement will be available to pick up from the dealer at which the log set was originally purchased or shipped directly to the customer if ordered online. This warranty does not cover breakage caused by excessive handling once installed and fired and does not cover improper installation. This warranty is limited to original purchaser only.

SCAN QR CODE FOR WARRANTY FORM



DO NOT RETURN TO STORE!



STOP CALL US FIRST

For immediate help with installation, product information or if your product arrives damaged, please call our toll free number at:

1-602-344-4217

(Monday - Friday, 8:00AM - 5:00PM, AZ Mountain Time)

or email us at:

customerservice@grandcanyongaslogs.com

OUR STAFF IS READY TO PROVIDE ASSISTANCE

RPG BRANDS

MODERN FLAMES[®]
ELECTRIC FIREPLACES

WILDFIRE[®]
OUTDOOR LIVING

GRAND CANYON
GAS LOGS

Copyright © 2024 RPG Brands and Grand Canyon Gas Logs. All rights reserved.
Products and specifications subject to change without notice.